

# Block diagram

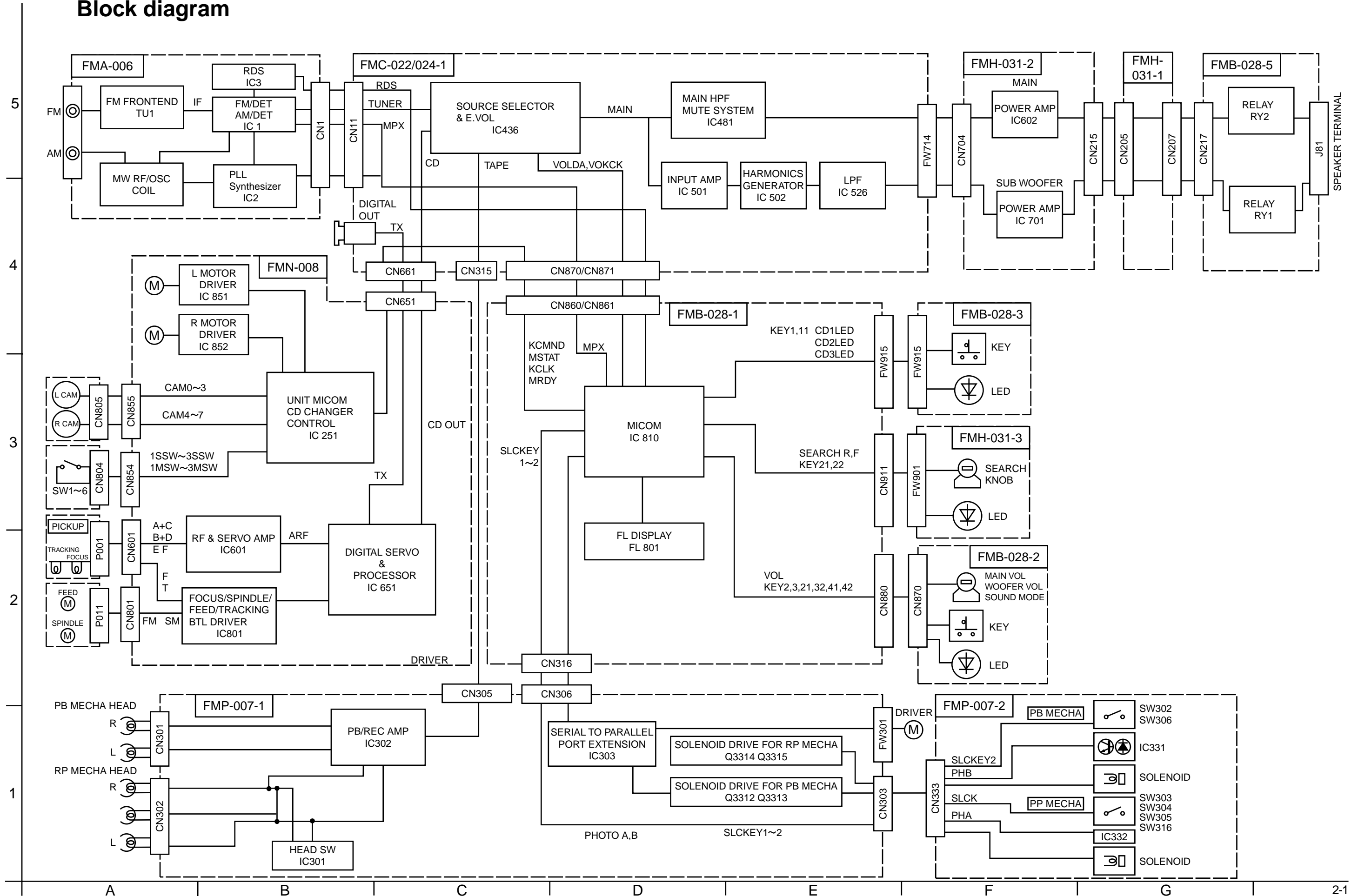

# Standard schematic diagrams

## Power supply section

POWER SUPPLY BLOCK

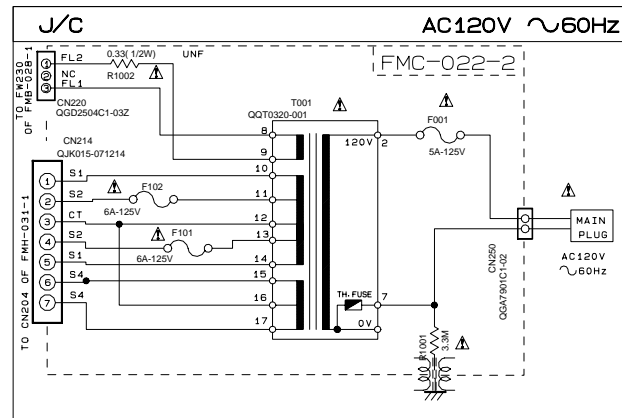

POWER SUPPLY BLOCK

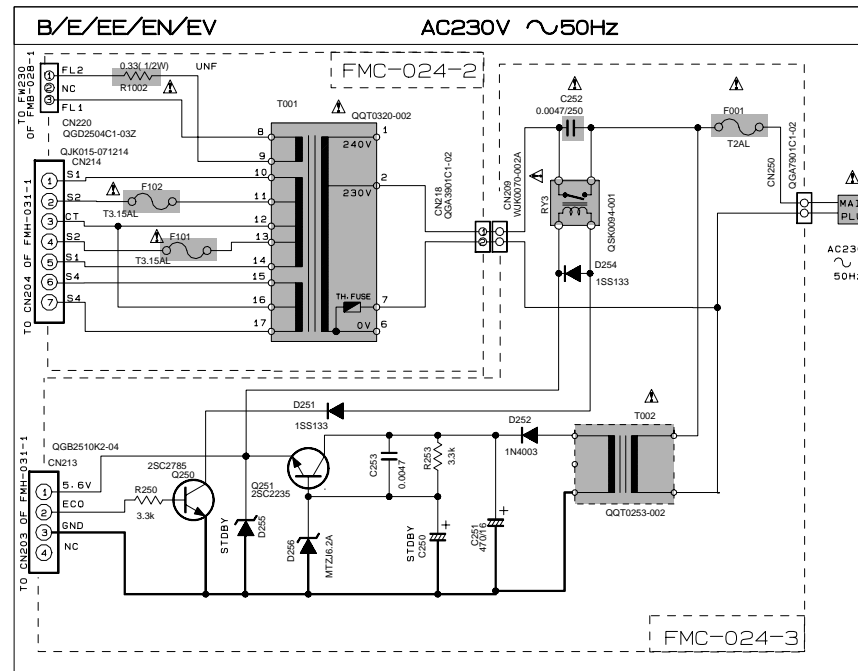

POWER SUPPLY BLOCK

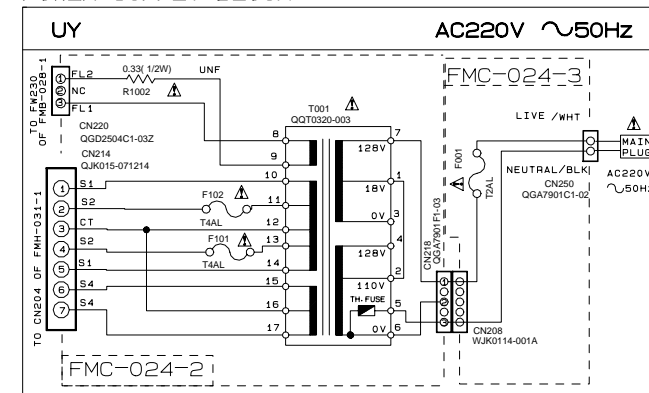

POWER SUPPLY BLOCK

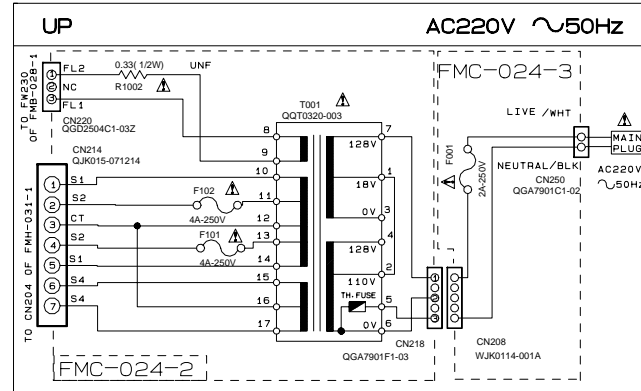

POWER SUPPLY BLOCK

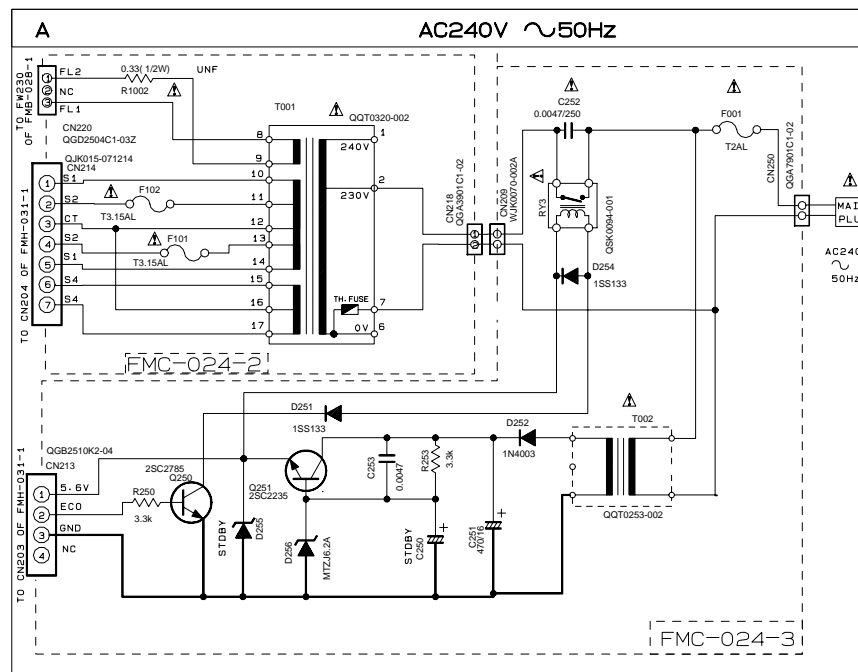

POWER SUPPLY BLOCK

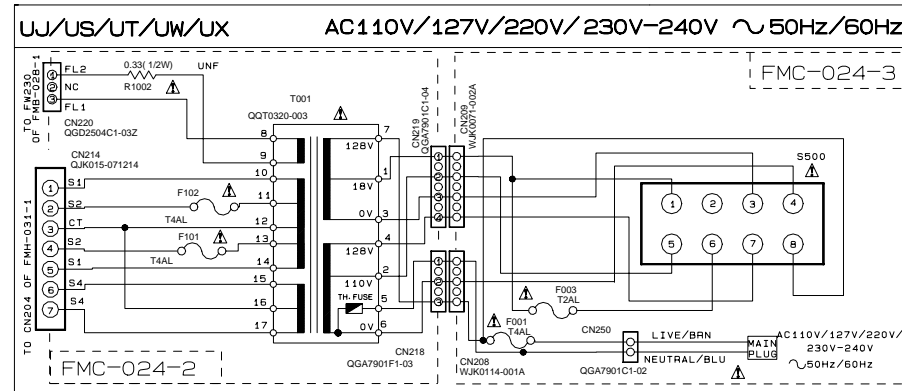

VOLTAGE SELECTOR LOCATION

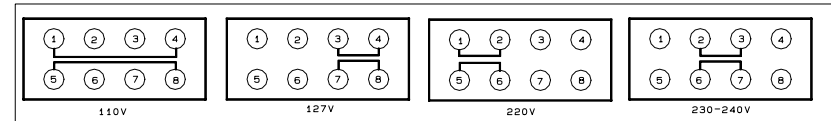

SHEET NUMBER	CIRCUITS DESCRIPTION
1/8	PRIMARY WITH MAINS TRANSFORMER
2/8	DC REGULATORS/AUDIO OUTPUT
3/8	EXTERNAL INPUT SOURCE SELECTOR SWITCH
4/8	FL DISPLAYS SYSTEM CONTROL LSI
5/8	USER CONTROL KEYS MIC AMP
6/8	CD SERVO AND CD SYSTEM CONTROL CD CHANGER MECHANISM CONTROL
7/8	TAPE DECK MECHANISM CONTROL TAPE CIRCUITS SUCH AS PRE-AMP AND BIAS
8/8	TUNER RF/IF/FM MULTIPLEX

VERSION CODES	
J	U.S.A.
C	CANADA
B	U.K.
E	CONTINENTAL EUROPE
EE	RUSSIA
EN	NORDIC COUNTRIES
EV	EASTERN EUROPE
A	AUSTRALIA
UJ	MILITARY
UP	KOREA
UT	TAIWAN
UX	SAUDI ARABIA
UY	ARGENTINA
UW	SOUTH AMERICA EXCEPT ARGENTINA
US	SINGAPORE AND UNIVERSAL EXCEPT ALL OF ABOVE

Parts are safety assurance parts.  
When replacing those parts make  
sure to use the specified one.

DC regulation & audio output section

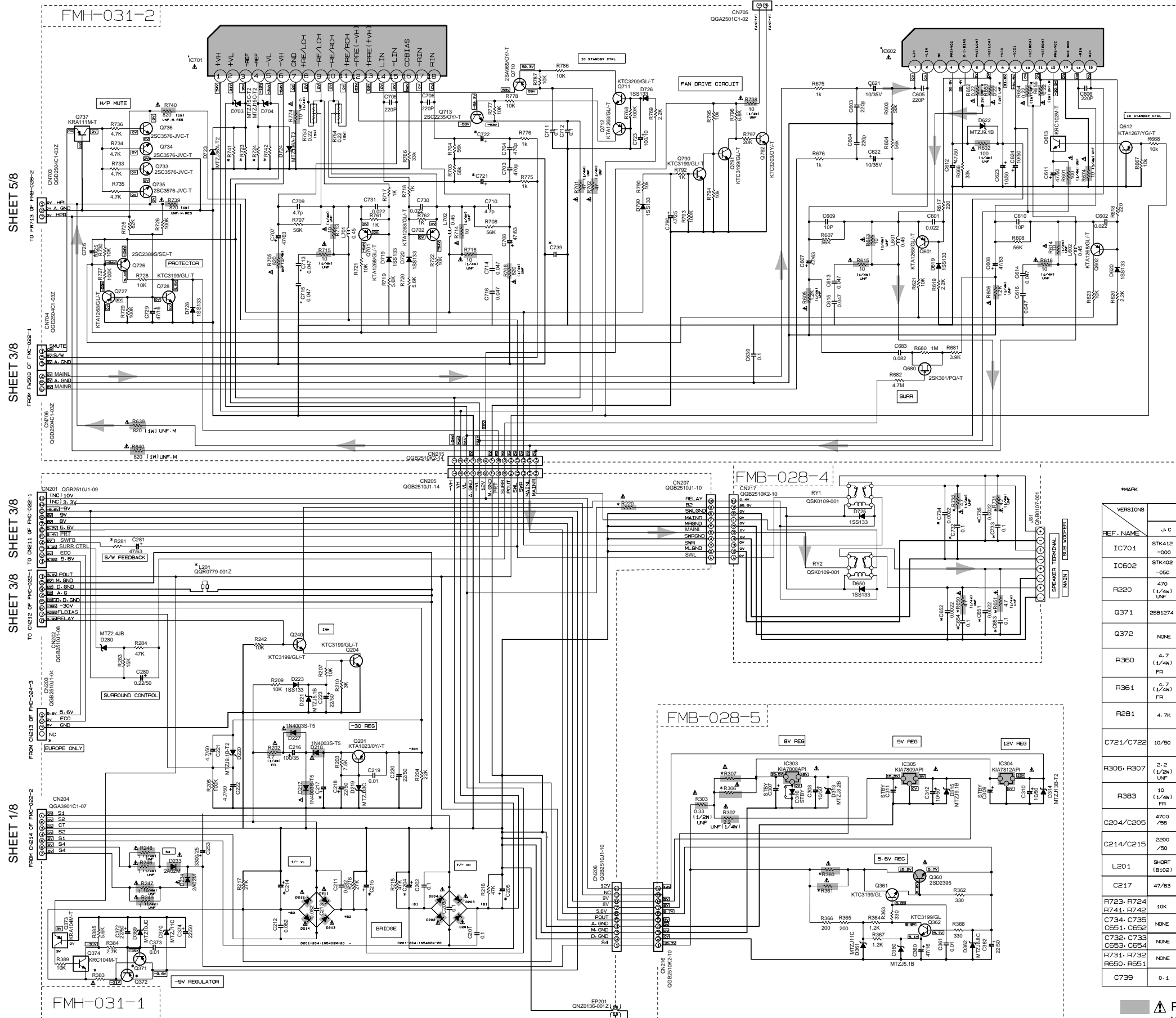

NOTES  
 1. VOLTAGES ARE DC-MEASURED WITH A DIGITAL VOLT METER OR OSCILLOSCOPE WITHOUT INPUT SIGNAL.  
 CONDITION — AUX MODE, VOL. HDN, BASS OFF  
 2. UNLESS OTHERWISE SPECIFIED:  
 RESISTORS ARE 1/4W ± 5% CARBON RESISTOR.  
 ALL RESISTANCE VALUES ARE IN OHMS.  
 ALL CAPACITORS ARE CERAMIC CAPACITOR OR POLAR CAPACITOR.  
 ALL CAPACITANCE VALUES ARE IN μF (PPF).  
 ALL DIMENSIONAL VALUES ARE IN MILLIMETERS.  
 ALL ELECTROLYTIC CAPACITORS ARE SHOWN IN THE FORM OF CAPACITANCE (μF)/RATED VOLTAGE (V).  
 ALL DIODES ARE 1N4148.

REF. NAME	MX-G70				MX-GT80				MX-GT90			
	J-C	A-E	U	UT	J-C	A-E	U	UT	J-C	A	U	UT
IC701	STK412-000	STK412-000	STK412-000	STK412-000	STK412-010	STK412-010	STK412-000	STK412-000	STK412-020	STK412-010	STK412-010	STK412-010
IC602	STK402-050	STK402-030	STK402-030	STK402-030	STK402-050	STK402-030	STK402-030	STK402-030	STK402-070	STK402-050	STK402-050	STK402-050
R220	470 (1/4W) UNF	150 (1/4W) UNF	150 (1/4W) UNF	150 (1/4W) UNF	470 (1/4W) UNF	150 (1/4W) UNF	150 (1/4W) UNF	150 (1/4W) UNF	470 (1/4W) UNF	150 (1/4W) UNF	150 (1/4W) UNF	150 (1/4W) UNF
Q371	2SB1274	NONE	NONE	NONE	2SB1274	NONE	NONE	NONE	2SB1274	NONE	NONE	NONE
Q372	NONE	KTA1023	KTA1023	KTA1023	NONE	KTA1023	KTA1023	KTA1023	NONE	KTA1023	KTA1023	KTA1023
R360	4.7 (1/4W) FR	2.2 (1/4W) FR	2.2 (1/4W) FR	2.2 (1/4W) FR	4.7 (1/4W) FR	2.2 (1/4W) FR	2.2 (1/4W) FR	2.2 (1/4W) FR	4.7 (1/4W) FR	2.2 (1/4W) FR	2.2 (1/4W) FR	2.2 (1/4W) FR
R361	4.7 (1/4W) FR	4.7 (1/4W) FR	4.7 (1/4W) FR	4.7 (1/4W) FR	4.7 (1/4W) FR	4.7 (1/4W) FR	4.7 (1/4W) FR	4.7 (1/4W) FR	4.7 (1/4W) FR	4.7 (1/4W) FR	4.7 (1/4W) FR	4.7 (1/4W) FR
R281	4.7K	4.7K	4.7K	4.7K	7.5K	5.6K	5.6K	5.6K	8.2K	5.6K	5.6K	5.6K
C721/C722	10/50	10/50	10/50	10/50	10/50	10/50	10/50	10/50	10/35	10/35	10/35	10/35
R306, R307	2.2 (1/2W) UNF	SHORT	SHORT	SHORT	2.2 (1/2W) UNF	SHORT	SHORT	SHORT	2.2 (1/2W) UNF	SHORT	SHORT	SHORT
R383	10 (1/4W) FR	SHORT (B123)	SHORT (B123)	SHORT (B123)	10 (1/4W) FR	SHORT (B123)	SHORT (B123)	SHORT (B123)	10 (1/4W) FR	SHORT (B123)	SHORT (B123)	SHORT (B123)
C204/C205	4700 /56	4700 /56	4700 /56	4700 /56	4700 /56	4700 /56	4700 /56	4700 /56	4700 /63	4700 /63	4700 /63	4700 /63
C214/C215	2200 /50	2200 /35	2200 /35	2200 /35	2200 /50	2200 /35	2200 /35	2200 /35	2200 /50	2200 /50	2200 /50	2200 /50
L201	SHORT (B102)	SHORT (B102)	SHORT (B102)	SHORT (B102)	SHORT (B102)	SHORT (B102)	SHORT (B102)	SHORT (B102)	SHORT (B102)	SHORT (B102)	SHORT (B102)	SHORT (B102)
C217	47/63	47/63	47/63	47/63	47/63	47/63	47/63	47/63	47/100	47/100	47/100	47/100
R723, R724	10K	6.8K	6.8K	6.8K	10K	6.8K	6.8K	6.8K	10K	6.8K	6.8K	6.8K
R741, R742	NONE	USE	NONE	NONE	NONE	USE	NONE	NONE	USE	NONE	NONE	NONE
C734, C735	NONE	USE	NONE	NONE	NONE	USE	NONE	NONE	USE	NONE	NONE	NONE
C651, C652	NONE	USE	NONE	NONE	NONE	USE	NONE	NONE	USE	NONE	NONE	NONE
C732, C733	NONE	USE	NONE	NONE	NONE	USE	NONE	NONE	USE	NONE	NONE	NONE
C653, C654	NONE	USE	NONE	NONE	NONE	USE	NONE	NONE	USE	NONE	NONE	NONE
R731, R732	NONE	USE	NONE	NONE	NONE	USE	NONE	NONE	USE	NONE	NONE	NONE
R650, R651	NONE	USE	NONE	NONE	NONE	USE	NONE	NONE	USE	NONE	NONE	NONE
C739	0.1	1/50	1/50	1/50	0.1	1/50	1/50	1/50	0.1	1/50	1/50	1/50

Parts are safety assurance parts. When replacing those parts make sure to use the specified one.

Main section

5

4

3

2

1

SHEET 4/8

SHEET 4/8

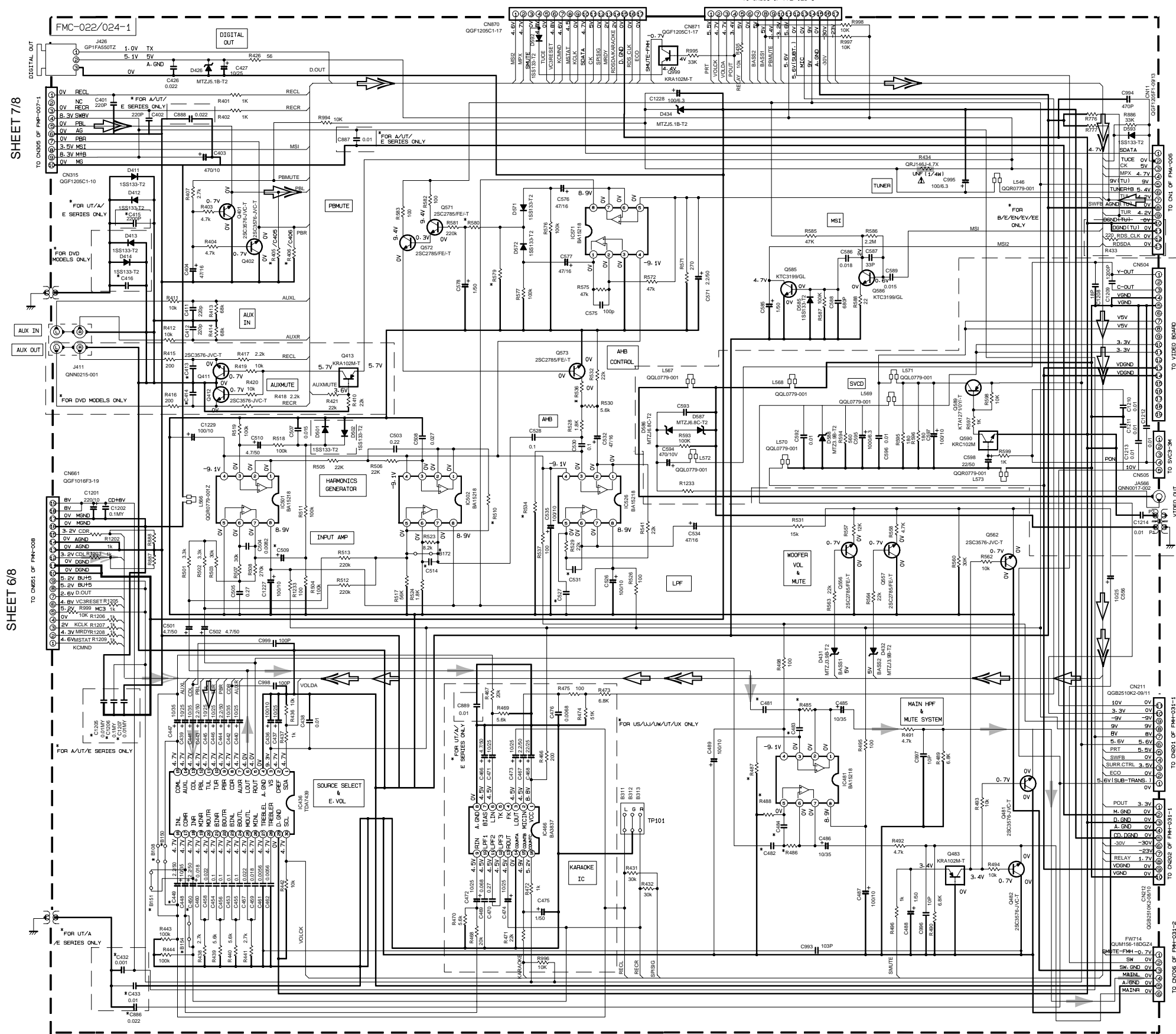

SHEET 8/8

SHEET 2/8

SHEET 2/8

SHEET 2/8

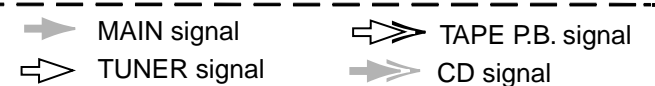

MODEL	CA-MXG70				MX-G70		CA-MXG71R	
	US/LW LX/LJ	UP/LY	UT	A	J/C	B/E EN/EE	B/E EN/EE	
R485/486				56K				
R487/488				82K				
C481/482 483/484				QFLM1HJ-223Z				
R536				15K				
C514				QFLM1HJ-473Z				
R510				100K				
C509				QETN1M-475Z				
R534				180K				
C531				QFVJ1HJ-274Z				
C527				QFLM1HJ-273Z				
R579				82K				
R580				2.2K				
C449	USED	NONE	USED	NONE	NONE	NONE		
C450	USED	NONE	USED	NONE	NONE	NONE		
B150	NONE	USED	NONE	NONE	USED	USED		
B151	NONE	USED	NONE	NONE	USED	USED		
B108	NONE	USED	NONE	NONE	USED	USED		
B154	NONE	USED	NONE	NONE	USED	USED		

MODEL	CA-MXG780				CA-MXG791R	
	J/C	US/LW LJ	UP/LY	UT	A	B/E/EN EV/EE
R485/486				51K		
R487/488				130K		
C481/482 483/484				QFLM1HJ-273Z		
R536				12K		
C514				QFLC1HJ-471Z		
R510				100K		
C509				QETN1M-106Z		
R534				180K		
C531				QFVJ1HJ-334Z		
C527				QFLM1HJ-103Z		
R579				100K		
R580				5.6K		
C449	NONE	USED	NONE	USED	NONE	NONE
C450	NONE	USED	NONE	USED	NONE	NONE
B150	USED	NONE	USED	NONE	USED	USED
B151	USED	NONE	USED	NONE	USED	USED
B108	USED	NONE	USED	NONE	USED	USED
B154	USED	NONE	USED	NONE	USED	USED

MODEL	MX-G790		CA-MXG790	
	J/C	US/LW LJ	UP/LY	A
R485/486				56K
R487/488				150K
C481/482 483/484				QFZ0160-223Z
R536				12K
C514				QFLC1HJ-417Z
R510				120K
C509				QETN1M-106Z
R534				220K
C531				QFVJ1HJ-184Z
C527				QFLM1HJ-183Z
R579				82K
R580				680
C449	NONE	USED	NONE	NONE
C450	NONE	USED	NONE	NONE
B150	USED	NONE	USED	USED
B151	USED	NONE	USED	USED
B108	USED	NONE	USED	USED
B154	USED	NONE	USED	USED

NOTES  
 1. VOLTAGES ARE DC-MEASURED WITH A DIGITAL VOLT METER OR OSCILLOSCOPE WITHOUT INPUT SIGNAL. CONDITION — AUX MODE. VOL. MIN. SLEWFOOPER VOL. 1.  
 2. UNLESS OTHERWISE SPECIFIED  
 RESISTORS ARE 1/4W 1% CARBON RESISTOR.  
 ALL RESISTANCE VALUES ARE IN OHM(S).  
 ALL CAPACITORS ARE CERAMIC CAPACITOR OR MYLAR CAPACITOR.  
 ALL CAPACITANCE VALUES ARE IN nF(pF).  
 ALL INDUCTANCE VALUES ARE IN mH(mH).  
 ALL E-CAPACITORS ARE SHOWN IN THE FORM OF CAPACITANCE (pF)/RATED VOLTAGE (V).  
 ALL DIODES ARE 1SS133

⚠ Parts are safety assurance parts. When replacing those parts make sure to use the specified one.

FL & system control section

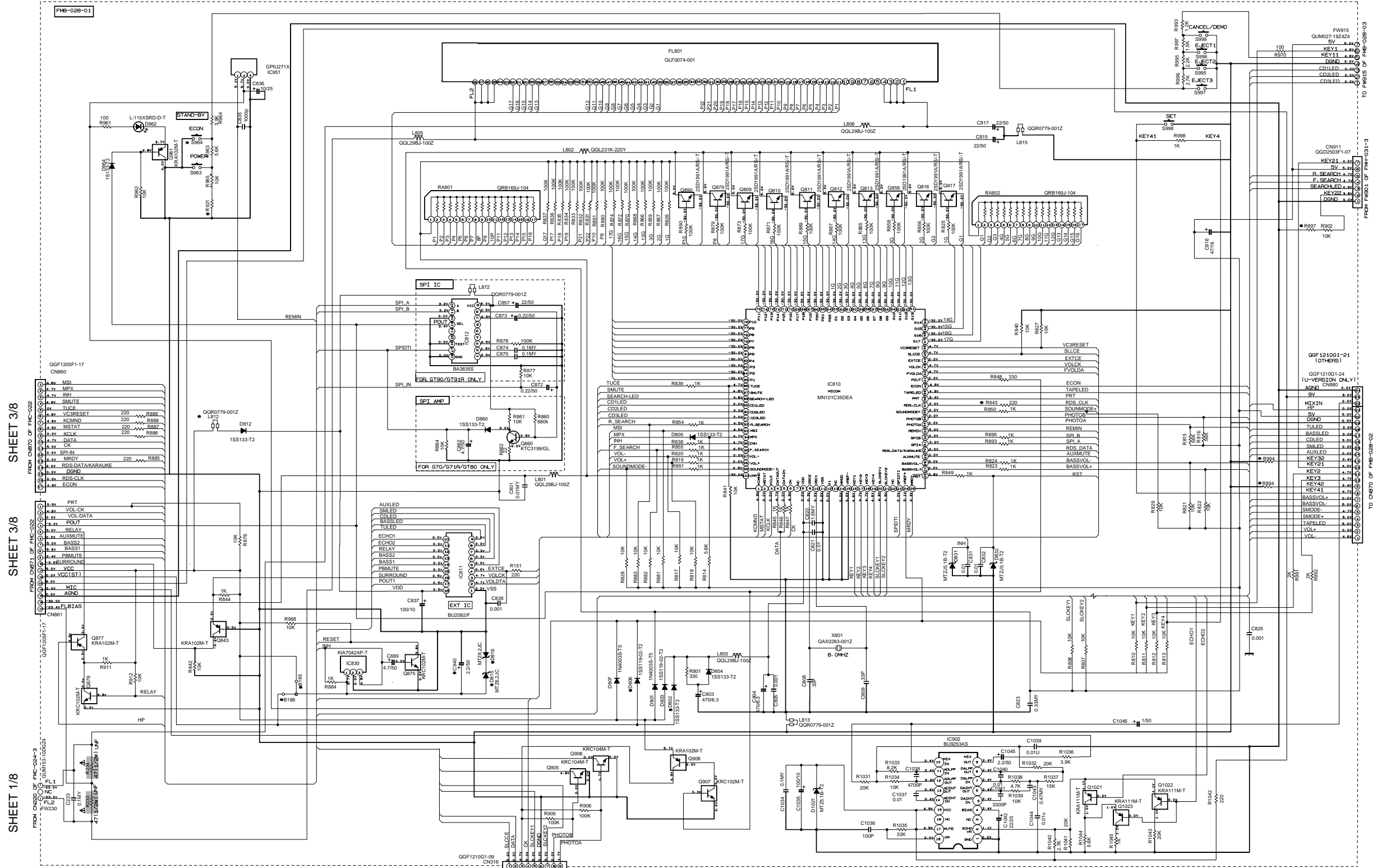

MARK	CA-MXG71R B-E-EN-EV	CA-MXG70 A	MX-G70 J-C	CA-MXG70 UX	CA-MXG70 UJ-UP-US-UT-UW	CA-MXG70 UY	MX-G71R EE	CA-MXG71R UJ-UP-US-UT-UW	MX-G71R C-J	CA-MXG71R B-E-EN-EV	MX-G71R EE	CA-MXG70 A	CA-MXG70 UY	CA-MXG70 UJ-UP-US-UT-UW	MX-G70 C-J	MX-G70 A	MX-G70 UY
R921	330K	330K	330K	330K	330K	330K	330K	75K	75K	75K	75K	75K	75K	18K	18K	18K	18K
R897	330K	75K	75K	75K	75K	75K	75K	75K	75K	330K	330K	75K	75K	75K	75K	75K	75K
R994	75K	330K	75K	18K	75K	75K	330K	75K	75K	75K	75K	75K	75K	75K	75K	330K	75K
R843	330K	330K	75K	18K	330K	18K	75K	330K	75K	330K	330K	75K	75K	330K	75K	330K	18K
R843	USE	USE	NONE	NONE	NONE	NONE	USE	NONE	NONE	USE	USE	NONE	NONE	NONE	NONE	NONE	NONE
X801	QAX0283-001Z	NONE	QAX0283-001Z	QAX0283-001Z	QAX0283-001Z	QAX0283-001Z	USE	QAX0283-001Z	QAX0283-001Z	QAX0283-001Z	QAX0283-001Z	QAX0283-001Z	QAX0283-001Z	QAX0283-001Z	QAX0283-001Z	QAX0283-001Z	QAX0283-001Z
S964	GSW0674-001Z	GSW0674-001Z	NONE	NONE	NONE	NONE	GSW0674-001Z	GSW0674-001Z	GSW0674-001Z	GSW0674-001Z	GSW0674-001Z	GSW0674-001Z	GSW0674-001Z	GSW0674-001Z	GSW0674-001Z	GSW0674-001Z	GSW0674-001Z
DB02	1SS133-T2	1SS133-T2	NONE	NONE	NONE	NONE	1SS133-T2	NONE	NONE	1SS133-T2	1SS133-T2	NONE	NONE	NONE	NONE	1SS133-T2	NONE
DB06	1SS119-02-T2	1SS119-02-T2	NONE	NONE	NONE	NONE	1SS119-02-T2	NONE	NONE	1SS119-02-T2	1SS119-02-T2	NONE	NONE	NONE	NONE	1SS119-02-T2	NONE
B189	NONE	NONE	USE	USE	USE	USE	NONE	USE	USE	NONE	NONE	USE	USE	USE	USE	USE	USE
B186	USE	USE	NONE	USE	USE	USE	USE	USE	USE	NONE	NONE	USE	USE	USE	USE	NONE	NONE
C940	NONE	2.2/50	NONE	NONE	NONE	NONE	NONE	NONE	NONE	2.2/50	2.2/50	NONE	NONE	NONE	NONE	2.2/50	NONE
DB15-DB16	NONE	MTZJ6-2C-T2	NONE	NONE	NONE	NONE	MTZJ6-2C-T2	NONE	NONE	MTZJ6-2C-T2	MTZJ6-2C-T2	NONE	NONE	NONE	NONE	MTZJ6-2C-T2	NONE

NOTES  
 1. VOLTAGES ARE DC-MEASURED WITH A DIGITAL VOLT METER OR OSCILLOSCOPE WITHOUT INPUT SIGNAL.  
 CONDITION - AUX MODE- VOL MIN- BASS LEVEL 1  
 2. UNLESS OTHERWISE SPECIFIED  
 RESISTORS ARE 1/4W ± 5% CARBON RESISTOR.  
 ALL RESISTANCE VALUES ARE IN OHM Ω.  
 ALL CAPACITANCE VALUES ARE IN PICOPI (p).  
 ALL INDUCTANCE VALUES ARE IN MICROH (μ).  
 ALL CAPACITORS ARE 50VDC IN THE FORM OF CAPACITANCE (μF/RATED VOLTAGE (V)).  
 ALL DIMENSIONS ARE IN MM (M).

Parts are safety assurance parts.  
 When replacing those parts make  
 sure to use the specified one.

■ Front section

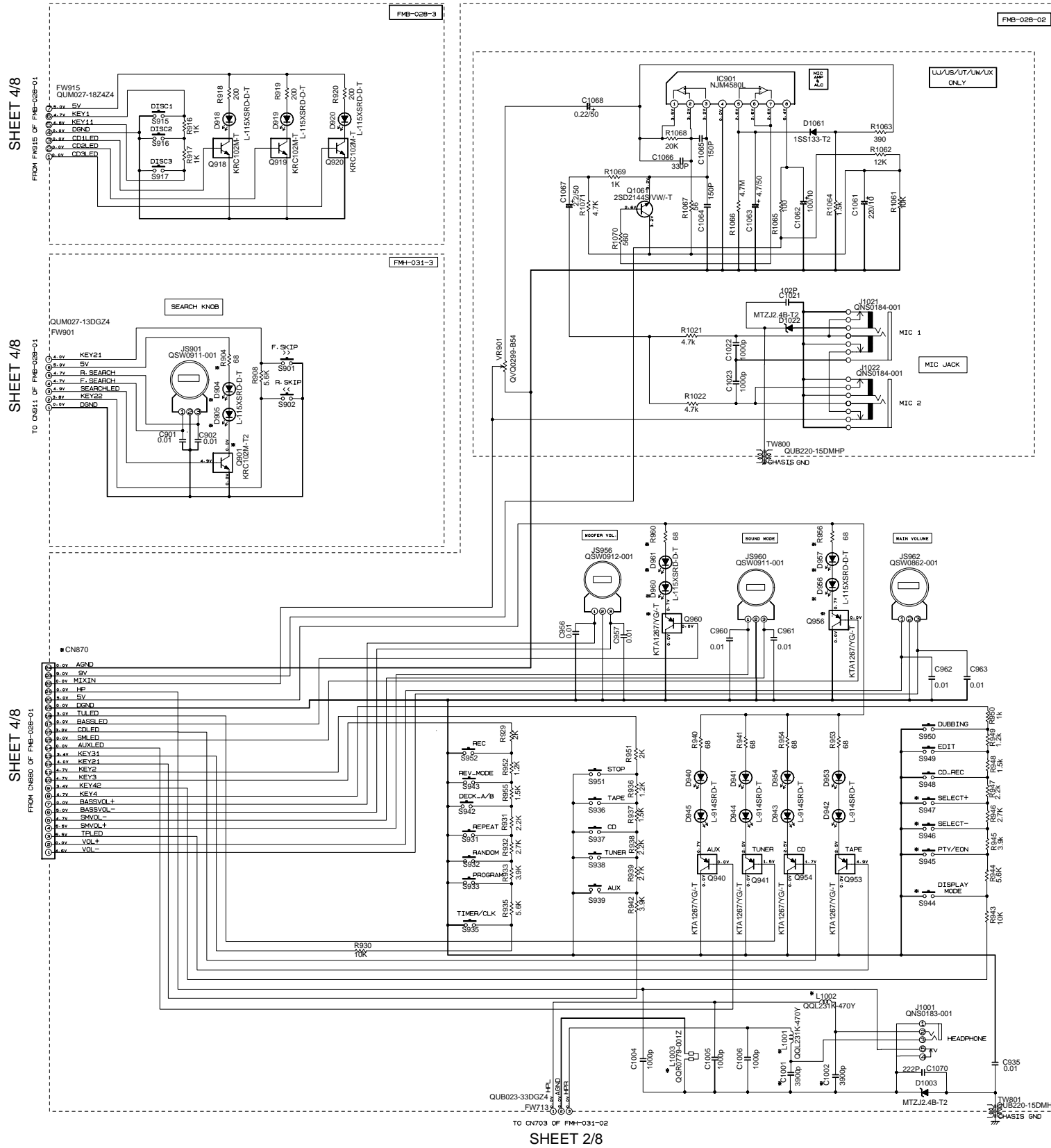

SHEET 2/8

NOTES  
 1. VOLTAGES ARE DC-MEASURED WITH A DIGITAL VOLT METER OR OSCILLOSCOPE WITHOUT INPUT SIGNAL.  
 CONDITION --- AUX MODE: VOL. MIN. BASS OFF  
 2. UNLESS OTHERWISE SPECIFIED  
 RESISTORS ARE 1/4W ± 5% CARBON RESISTOR  
 ALL RESISTANCE VALUES ARE IN OHM Ω  
 ALL CAPACITORS ARE ORGANIC CAPACITOR OR MLAR CAPACITOR  
 ALL CAPACITANCE VALUES ARE IN μF (μF)  
 ALL INDUCTANCE VALUES ARE IN mH (mH)  
 ALL ELECTROLYTIC CAPACITORS ARE POLARIZED  
 ALL ELECTROLYTIC CAPACITORS ARE SHOWN IN THE FORM OF CAPACITANCE (μF)/RATED VOLTAGE (V)  
 ALL DIMENSIONS ARE IN MILLIMETERS

MARK	CA-MXG71R B. E. EN. EV	CA-MXG70 A	MX-G70 J. C	CA-MXG70 UK	UJ. LP. US. UT. UW	CA-MXG70 UY	MX-G71R EE	CA-MXG70 UJ. LP. US. UT. UW	MX-G71R EE	CA-MXG71R B. E. EN. EV	MX-GT91R A	CA-MXG780 UY	CA-MXG780 UY	CA-MXG790 UJ. LP. US. LW	MX-GT90 C. J	MX-GT90 A	MX-GT90 UY
D904, D905, D956, D957, D960, D961	NONE	NONE	NONE	NONE	NONE	NONE	NONE	NONE	NONE	L-115XSRD-D-T	L-115XSRD-D-T	L-115XSRD-D-T	NONE	NONE	L-115XSRD-D-T	L-115XSRD-D-T	L-115XSRD-D-T
S944, S945, S946, S947, L1001, L1002, C1001, C1002, L1003	G9W0B25-001Z	NONE	NONE	NONE	NONE	NONE	NONE	G9W0B25-001Z	NONE	NONE	G9W0B25-001Z	G9W0B25-001Z	NONE	NONE	NONE	NONE	NONE
R904, R956, R960, G901	NONE	NONE	NONE	NONE	NONE	NONE	NONE	NONE	NONE	KRC102M-T	KRC102M-T	NONE	NONE	KRC102M-T	KRC102M-T	KRC102M-T	KRC102M-T
CN870	G9F1205F1-22	G9F1205F1-22	G9F1205F1-22	G9F1205F1-22	G9F1205F1-24	G9F1205F1-24	G9F1205F1-22	G9F1205F1-22	G9F1205F1-22	G9F1205F1-22	G9F1205F1-22	G9F1205F1-22	G9F1205F1-22	G9F1205F1-22	G9F1205F1-22	G9F1205F1-24	G9F1205F1-24
G956, G960	NONE	NONE	NONE	NONE	NONE	NONE	NONE	NONE	NONE	KTA1267/YG/-T	NONE	NONE	NONE	KTA1267/YG/-T	KTA1267/YG/-T	KTA1267/YG/-T	KTA1267/YG/-T

CD serbo section

5

4

3

2

1

A

B

C

D

E

F

G

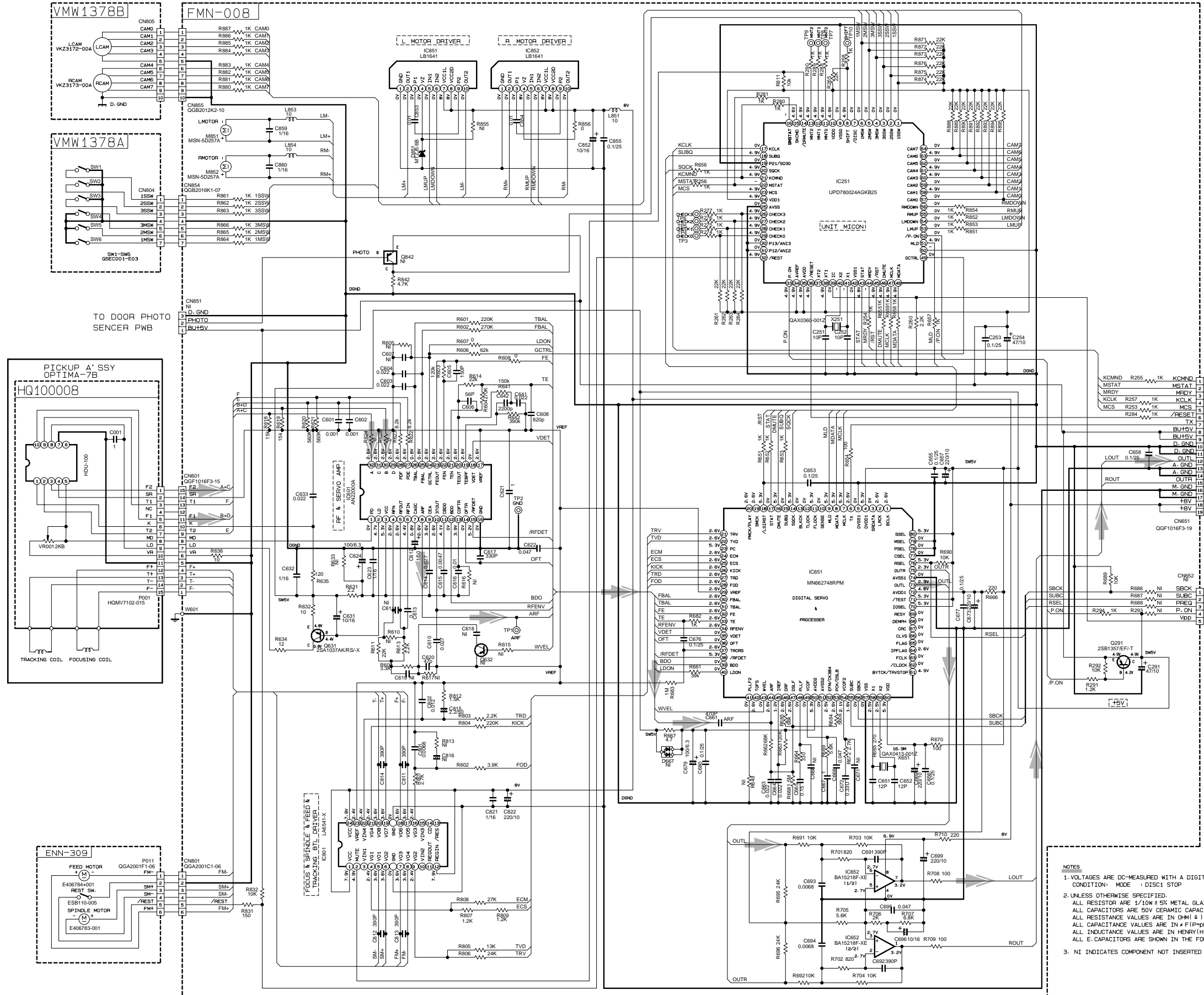

TO CN651 OF FMC-022-1 SHEET 3/8

➔ CD signal

- NOTES**
1. VOLTAGES ARE DC-MEASURED WITH A DIGITAL VOLT METER  
CONDITION: MODE : DISC1 STOP
  2. UNLESS OTHERWISE SPECIFIED.  
ALL RESISTOR ARE 1/10W ± 5% METAL GLAZE RESISTOR.  
ALL CAPACITORS ARE 50V CERAMIC CAPACITOR OR 50V MYLAR CAPACITOR.  
ALL RESISTANCE VALUES ARE IN OHM (Ω).  
ALL CAPACITANCE VALUES ARE IN μF (μF).  
ALL INDUCTANCE VALUES ARE IN HENRY (H).  
ALL E. CAPACITORS ARE SHOWN IN THE FORM OF CAPACITANCE (μF)/RATED VOLTAGE (V).
  3. NI INDICATES COMPONENT NOT INSERTED

Head amplifier section

CASSETTE MECHA CONTROL CIRCUIT [SLC]

FMP-007-1

FMP-007-2

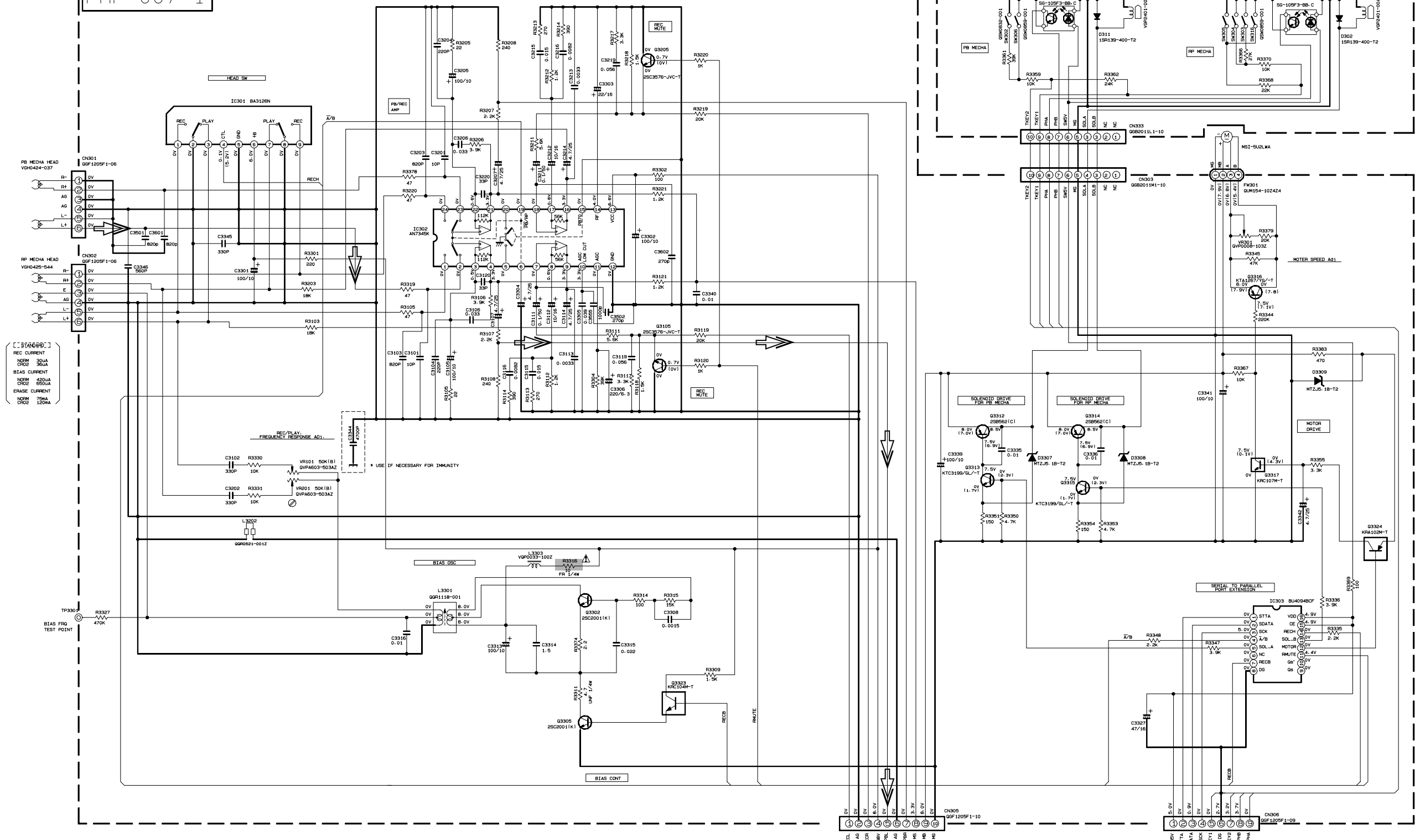

- [[STANDARD]]
- REC CURRENT NORM 300A
  - CROSS 300A
  - BIAS CURRENT NORM 4500A
  - CROSS 5500A
  - ERASE CURRENT NORM 700A
  - CROSS 1200A

NOTES

- VOLTAGES ARE DC-MEASURED WITH A DIGITAL VOLT METER OR OSCILLOSCOPE WITHOUT INPUT SIGNAL. ( ) IS INVERT MODE
- UNLESS OTHERWISE SPECIFIED

ALL RESISTANCE VALUES ARE IN OHM(Ω).

ALL CAPACITORS ARE CERAMIC CAPACITOR

ALL CAPACITANCE VALUES ARE IN μF(μF).

ALL INDUCTANCE VALUES ARE IN mH(mH).

ALL E. CAPACITORS ARE SHOWN IN THE FORM OF CAPACITANCE (μF)/RATED VOLTAGE (V).

PP PLYPROPYLENE CAPACITOR

SHEET 3/8

FROM CN315 OF FMC-022-1

SHEET 4/8

FROM CN316 OF FMB-028-1

Parts are safety assurance parts. When replacing those parts make sure to use the specified one.

TAPE P.B. signal

SHEET 7/8

5

4

3

2

1

A B C 2-8 D E F G H



■ Tuner section

- NOTES
- VOLTAGES ARE DC-MEASURED WITH A DIGITAL VOLT METER.
  - ALL RESISTORS ARE 1/8W ±5% METAL GLAZE RESISTOR.
  - ALL RESISTANCE VALUES ARE IN OHM(Ω).
  - ALL CAPACITANCE VALUES ARE IN pF(pF).
  - ALL E. CAPACITORS ARE SHOWN IN THE FORM OF CAPACITANCE (pF)/RATED VOLTAGE (V).
  - SI DIODES (D) ARE ALL 1SS133-T THAT CAN BE CHANGED TO SIMILAR DIODE SUCH AS MA165 OR HSS104J.
  - PARTS NO. OF TRANSISTORS ARE AS FOLLOWS.  
Q1 2SC2814/4-5/-X Q2, Q3 2SC2412K/R/-X  
Q4, Q5 DTA114YKA-X

B. INSIDE OF DIGITAL TRANSISTORS ARE SHOWN AS FOLLOWS.

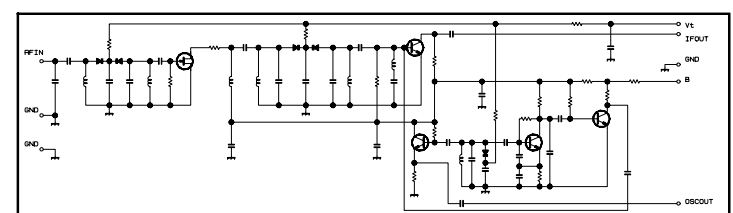
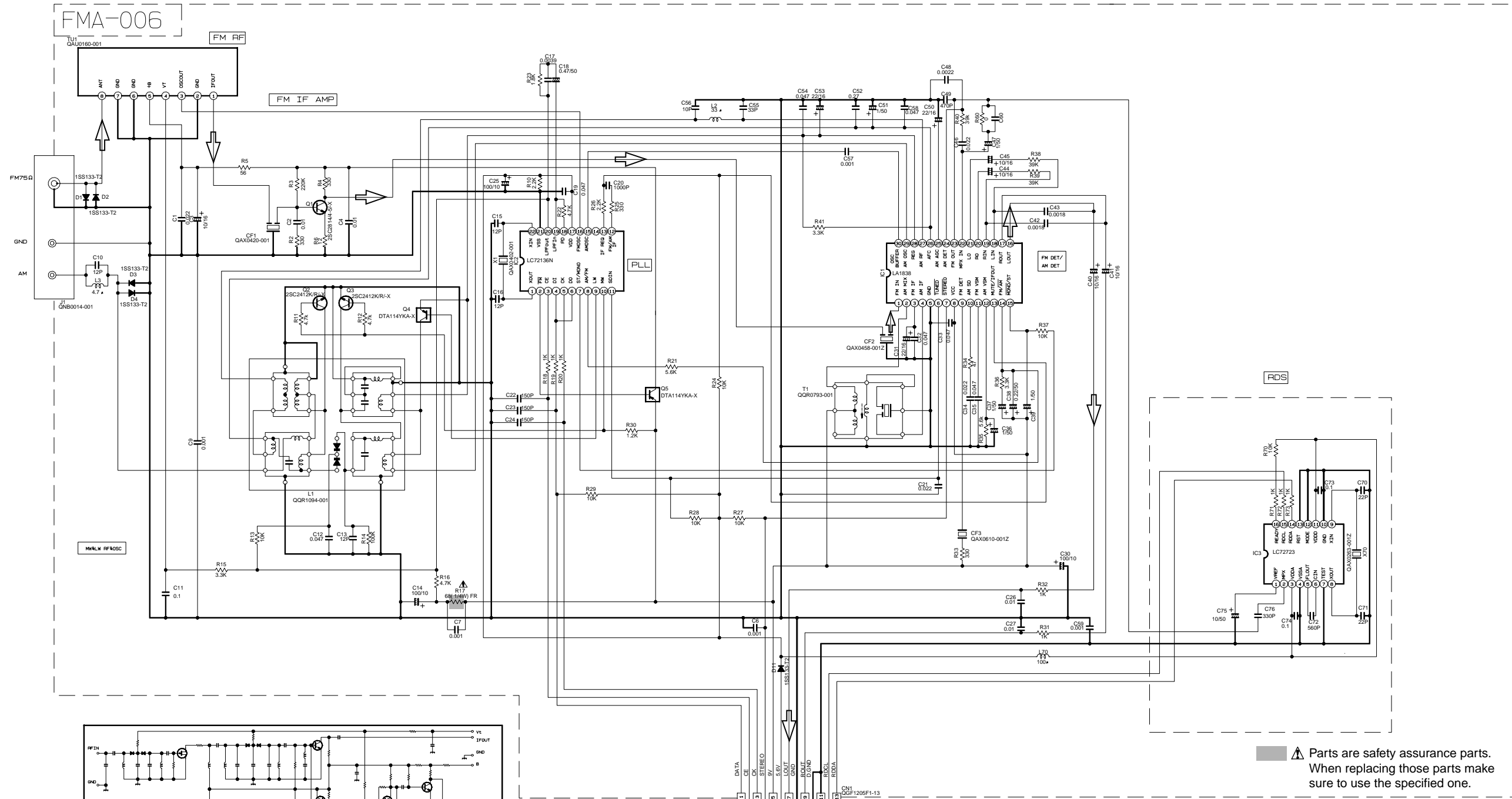
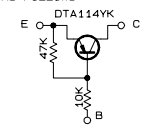

⚠ Parts are safety assurance parts. When replacing those parts make sure to use the specified one.

➡ FM/TUNER signal

FROM CN11 OF FMC-022

SHEET 3/8

CONDITION	PIN NO.	1	2	3	4	5	6	7	8	9	10	11	12	13	14	15	16	17	18	19	20	21	22	23	24	25	26	27	28	29	30
IC1	FM NO SIGNAL	3.6	8.9	3.6	3.6	0	5.0	5.0	8.9	8.9	1.3	0.1	0	0.9	7.8	7.8	4.3	4.3	4.3	4.3	3.4	3.4	2.8	3.4	0	0	3.5	3.5	3.6	3.6	2.7
	FM 60dB STEREO	3.6	8.9	3.6	3.6	0	5.0	5.0	8.9	8.9	1.3	4.3	0	0.9	7.8	7.8	4.3	4.3	4.3	4.3	3.4	3.4	2.8	3.4	0	0	3.6	3.6	3.6	3.6	2.7
	AM NO SIGNAL	3.5	9.0	3.5	3.5	0	5.0	5.1	9.0	2.6	1.3	0	0	0.9	4.7	5.5	4.3	4.3	4.3	3.3	3.2	2.8	ust	0.7	0.7	3.6	3.6	3.6	3.6	2.1	
IC2	FM NO SIGNAL	2.5	0	0	5.0	4.9	5.0	7.9	7.8	3.6	6.1	5.1	0	0	0	0	2.5	5.1	0.9	0.9	3.8	0	2.3								

T <sub>r</sub> NO.	Q1	Q5
PIN NO.	E C B E C B	
FM 87.5MHz NO SIGNAL	0 7.1 0.85	8.9 8.9 0
AM 522kHz NO SIGNAL	0 0 0 9.0	0 8.9

T <sub>r</sub> NO.	Q2	Q3	Q4
PIN NO.	E C B E C B E C B		
AM 522kHz NO SIGNAL	0 0 0.7	0 0 0.7	0 3.6 0.7
AM 144kHz NO SIGNAL	0 0 0.3	0 0.3 0.3	3.6 3.6 3.6

# Printed circuit boards

## ■ Main board

5

4

3

2

1

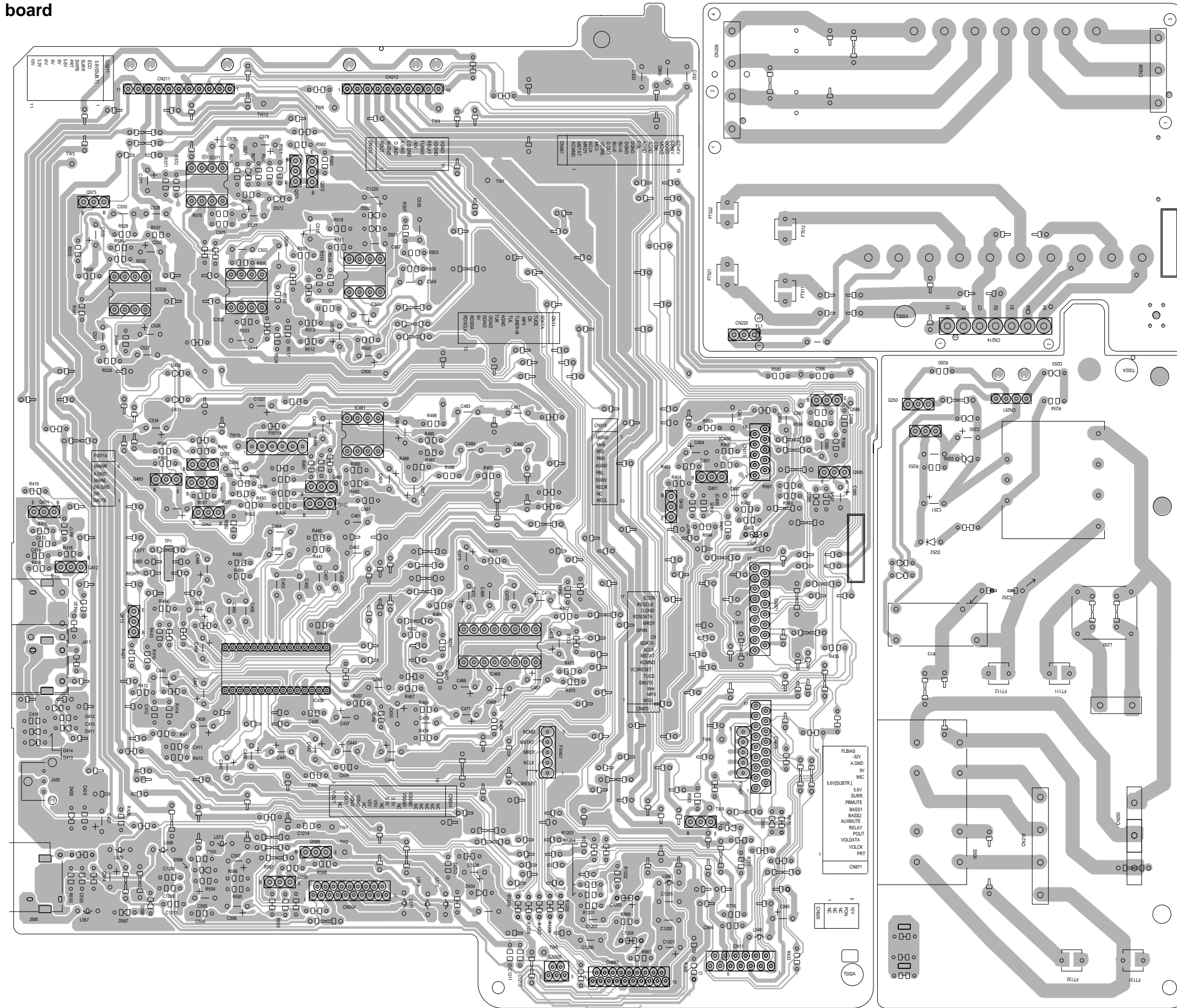

A B C 2-10 D E F G H

■ Regulation & amplifier board

5

4

3

2

1

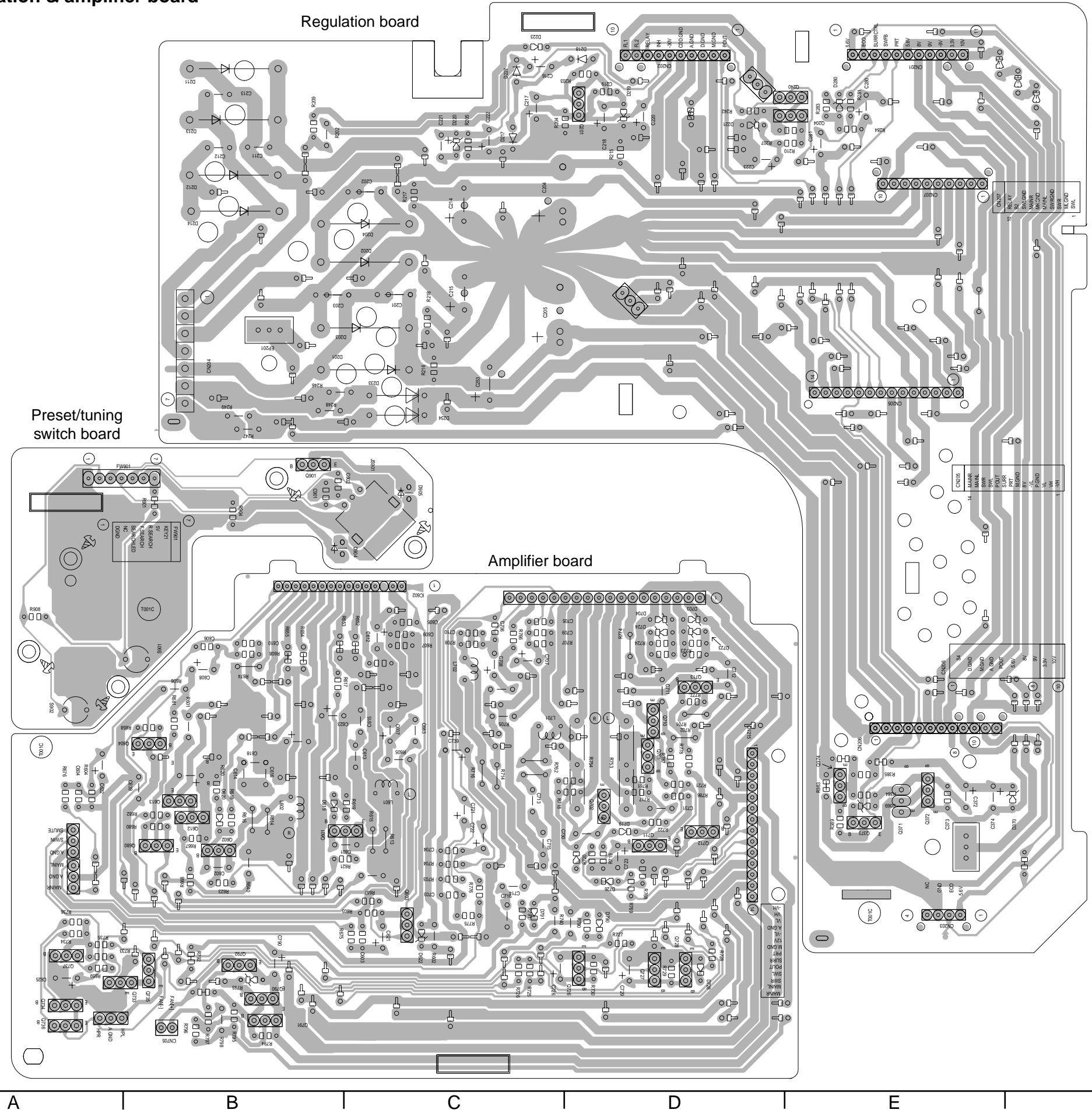

A

B

C

D

E

F

G

■ Front board

Display & system control board

Operation switch board

5

4

3

2

1

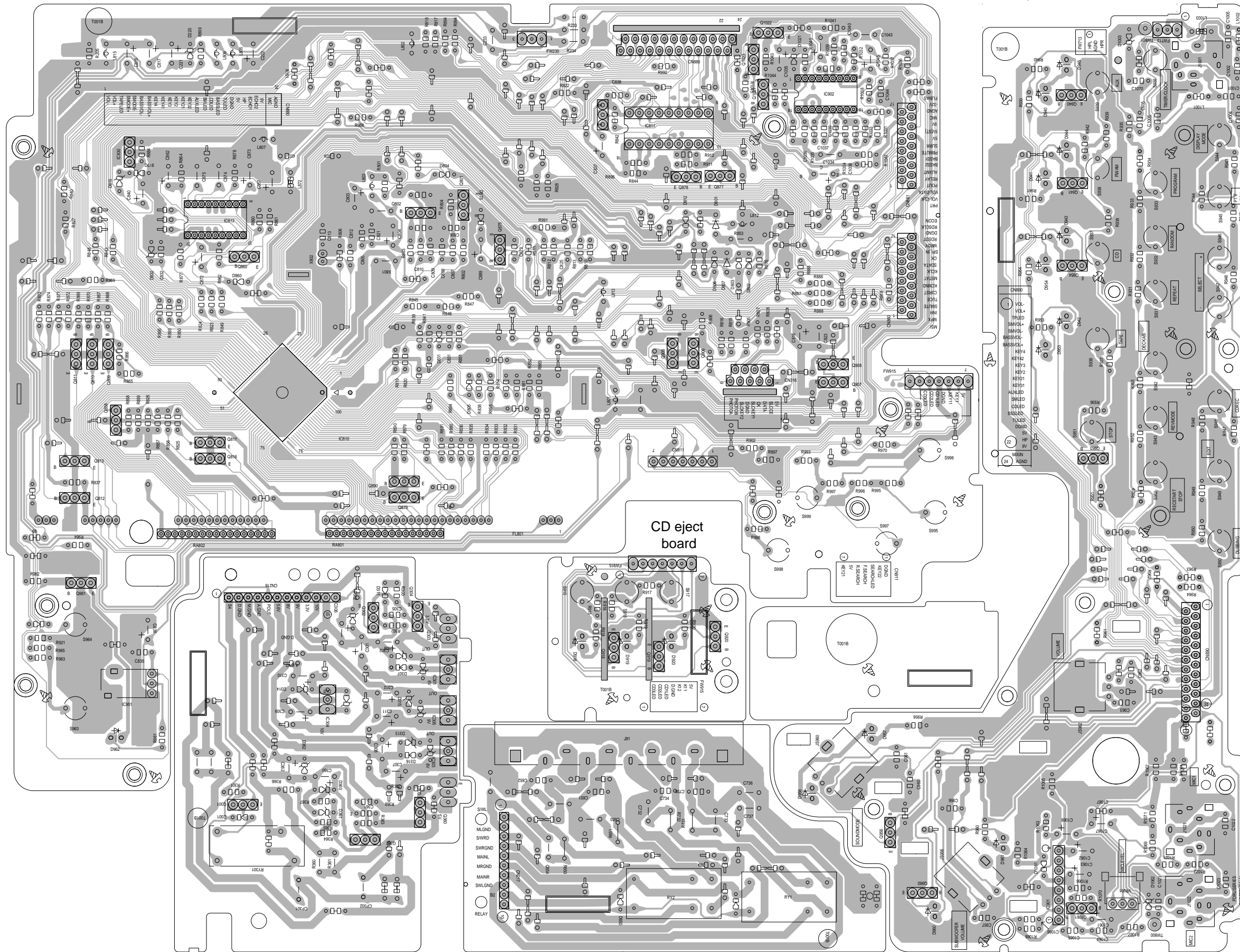

Voltage board

Speaker terminal board

A

B

C

2-12

D

E

F

G

H

■ CD servo control board

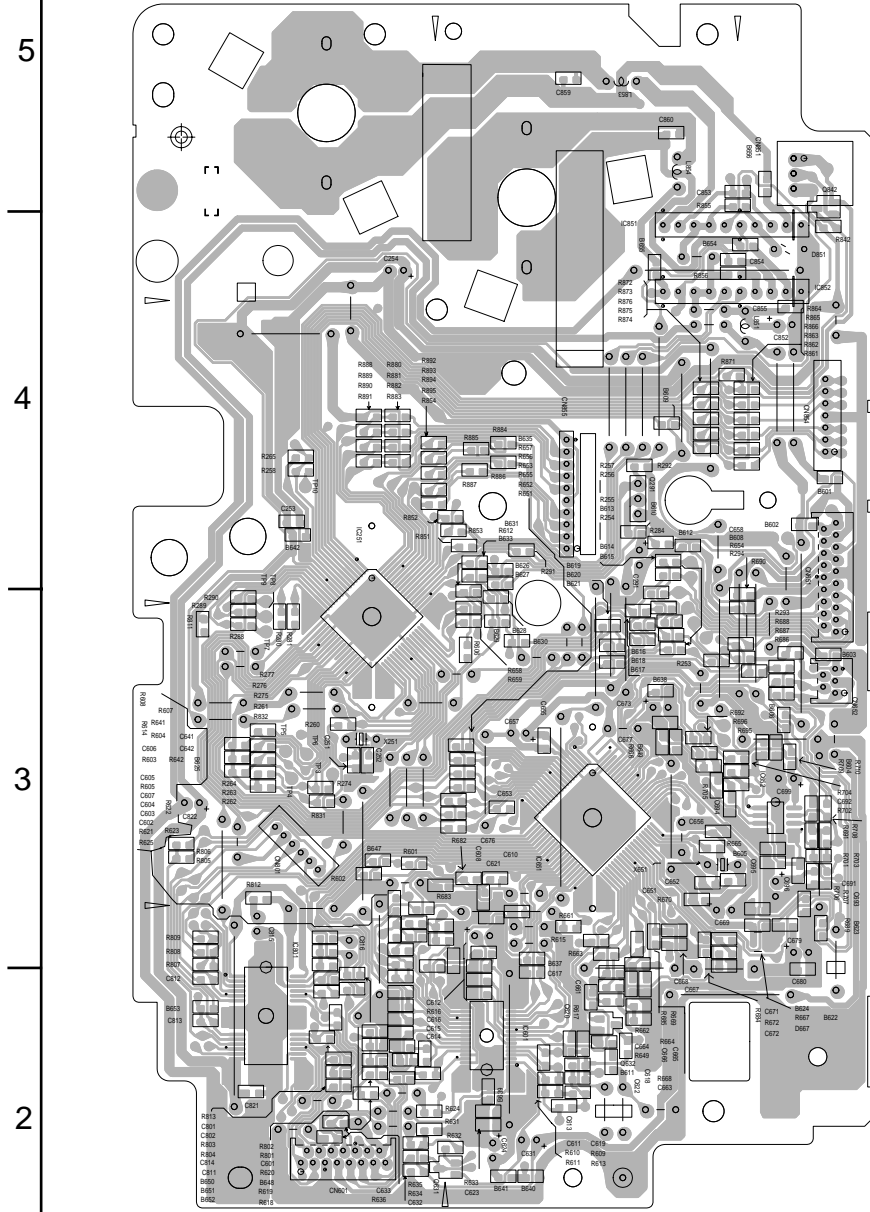

■ Head amplifier & mechanism control board

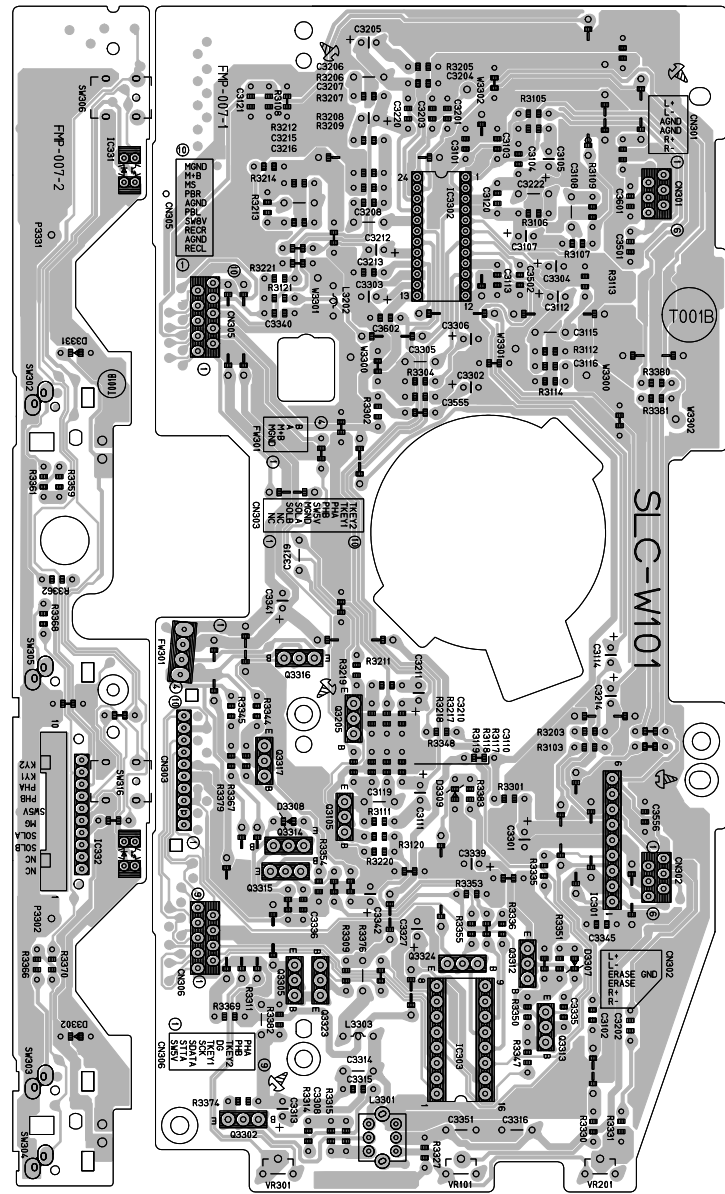

■ Tuner board

